

M2M CONTROL C450

Technical Manual

Version 2.1



Introduction

This manual contains technical documentation which allows for easy installation and use of the **M2M Control C450** product. For information on the programming and software configuration of the product please refer to the M2M CONTROL IDE documentation.

The M2M Control C450 has been designed from the ground up for professional wireless industrial applications with its strong on-board I/O capabilities and multiple communication interfaces such as: dual RS232, dual RS485, 1-Wire and USB. For world-wide usage in any network environment the M2M Control C450 offers a full quad-band GSM engine with a switchable dual antenna design supporting both an on-board as well as an external GSM antenna.

The on-board I/O system can be expanded almost indefinitely and completely transparently by adding external MODBUS compatible I/O modules! This unique I/O expansion capability, combined with the ability to operate as a MODBUS master and slave simultaneously, positions the M2M Control C450 as the perfect product for SCADA-like applications.

The M2M Control C450 is based on the X32 Execution Architecture offering high performance along with a large memory capacity for both program and data - meeting the requirements of today's most demanding and sophisticated M2M/IoT applications.

The M2M Control C450 rests on the **M2M CONTROL Professional Series RTCU Platform** which brings all the necessary tools together to develop, implement and maintain today's sophisticated M2M/IoT applications.

The term "**RTCU**" stands for **Remote Terminal Control Unit** and constitutes a unique combination of a programmable control-unit with the possibility of both digital- and analog I/O plus a GSM modem.

The development task is supported by the **free M2M CONTROL IDE development environment**, complimented by a large and comprehensive documentation and application example library.

M2M Control GPRS Gateway is the corner stone of the communication infrastructure and ensures reliable two-way device communication in any network environment.

Deploying and maintaining new application and firmware versions for devices in the field is handled by the powerful **M2M Control Upgrade & Deployment Server**.

For detailed information on the powerful M2M CONTROL RTCU Platform, please refer to the *M2M CONTROL RTCU Platform datasheet*.

The technical highlights of the M2M Control C450:

- Based on the **M2M CONTROL RTCU Platform**.
- X32 execution architecture.
 - M2M CONTROL IDE development tool with full a featured device simulator.
 - Huge standard API with more than 800+ functions.
 - Comprehensive protocol support, including:
TCP-UDP/IP, FTP, SMTP, RACP, MQTT, MODBUS.
- World-wide Quad-band GSM **engine**.
- **Internal and external antenna** connector. Selectable from application.
- Medium range **ISM band RF transceiver** with on-board antenna.
- Internal SIM-card reader.
- **Digitized audio** can be played over GSM.
- **DTMF** support for implementation of Interactive Voice Response applications.
- Large data-flash/logger memory with a capacity of **4.5 MB**.
- Internal **4 MB FAT32 flash drive**.
- Standard FAT32 **Micro SD-CARD** reader with up to 32 GB capacity.
- **2 x RS232** channels and **2 x RS485** channels.
- **4 x analog inputs** with 0..10 volt / 0..20 mA with **12 bit precision**.
- **4 x analog outputs** with 0..10 volt / 0..20 mA.
- **5 x digital inputs** and **4 x high-power relays**.
- Up to 4 digital inputs can be configured as IEC62053-31 Class A compliant.
- **Expandable I/O** with standard MODBUS modules.
- **1-Wire bus** for accessories such as ID-button reader, temperature sensors, etc.
- Wide AC/DC power operating range from **85..265VAC / 8..36 VDC**.
- On-board **high-capacity Li-Ion battery**.
- Advanced **power-management** with wake-up on a wide range of events.
- High-speed **USB programming** connector.
- Housed in a **ruggedized plastic** encapsulation with cable glands.
- **IP65** water protected for outdoor usage.
- Fully supported by **M2M Control GPRS Gateway** and the **M2M Control Upgrade & Deployment Server**.
- **Accessories:** Wi-Fi, Ethernet, Bluetooth and MDT-200 terminal.

*** * * * THIS PAGE IS INTENTIONALLY LEFT BLANK * * * ***

Table of Contents

Introduction.....	2
The technical highlights of the M2M Control C450:.....	3
Table of Contents.....	5
Graphical view.....	7
Connection Overview.....	8
Power supply.....	11
DC Supply.....	12
AC Supply.....	13
Digital I/O.....	15
Relay outputs.....	15
Load Noise.....	15
Digital inputs / S0 inputs / wakeup (<i>ignition</i>) input.....	16
Analog I/O.....	18
Analog inputs.....	18
Analog outputs.....	20
USB programming port.....	21
RS232 communication ports (EIA/TIA-232 and V.28/V.24 compatible).....	21
RS232 port 1.....	21
RS232 port 2.....	21
RS485 communication ports (<i>EIA/TIA-485-A compatible</i>).....	22
RS485 port 1.....	23
RS485 port 2.....	23
1-Wire.....	24
DC-Out.....	24
3.3V DC-Out.....	24
12V/24V DC-Out.....	24
LED Indicators.....	26
User LED A and B.....	26
System LED S1 and S2.....	27
Switches.....	28
DIP-Switch.....	28
System switch (RST).....	28
Internal Li-Ion battery.....	29
GSM.....	30
GSM Antenna.....	30
SIM-Card.....	31
Micro SD card reader.....	32
Approved Micro SD cards.....	33

ISM RF	34
Barcode / unit type	34
Power consumption	35
External DC supply	35
Internal battery	35
External AC supply	36
Appendix A – Unit configuration guide	37
Appendix B – Installing the SIM card.....	40
Appendix C – Installing the Micro SD card.....	41
M2M Control C450 Specifications.....	42

Graphical view

On the front of the M2M Control C450 are four user controlled LED's and three system LED's for simple information and status.

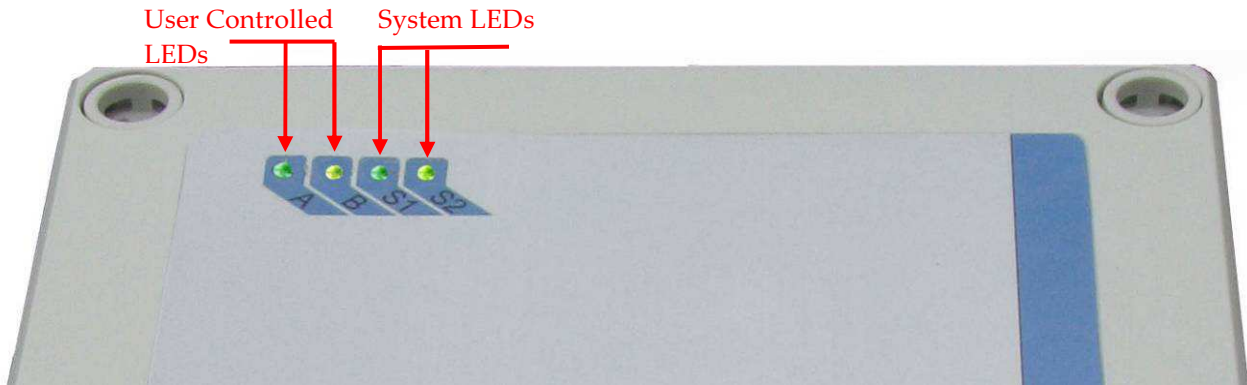

The external GSM antenna connector is located at the side of the device as shown below:



Connection Overview

Connections to external equipment are done via large and easy-to-use screw terminal blocks which are accessible when the lid is removed. The placement of the terminals makes installation easy using the PG glands and thereby maintaining the IP-67 protection.

The M2M Control C450 is delivered with three PG11 glands and additional two PG9 blind plugs that can be replaced with PG9 glands if additional cable entry capacity should be required.

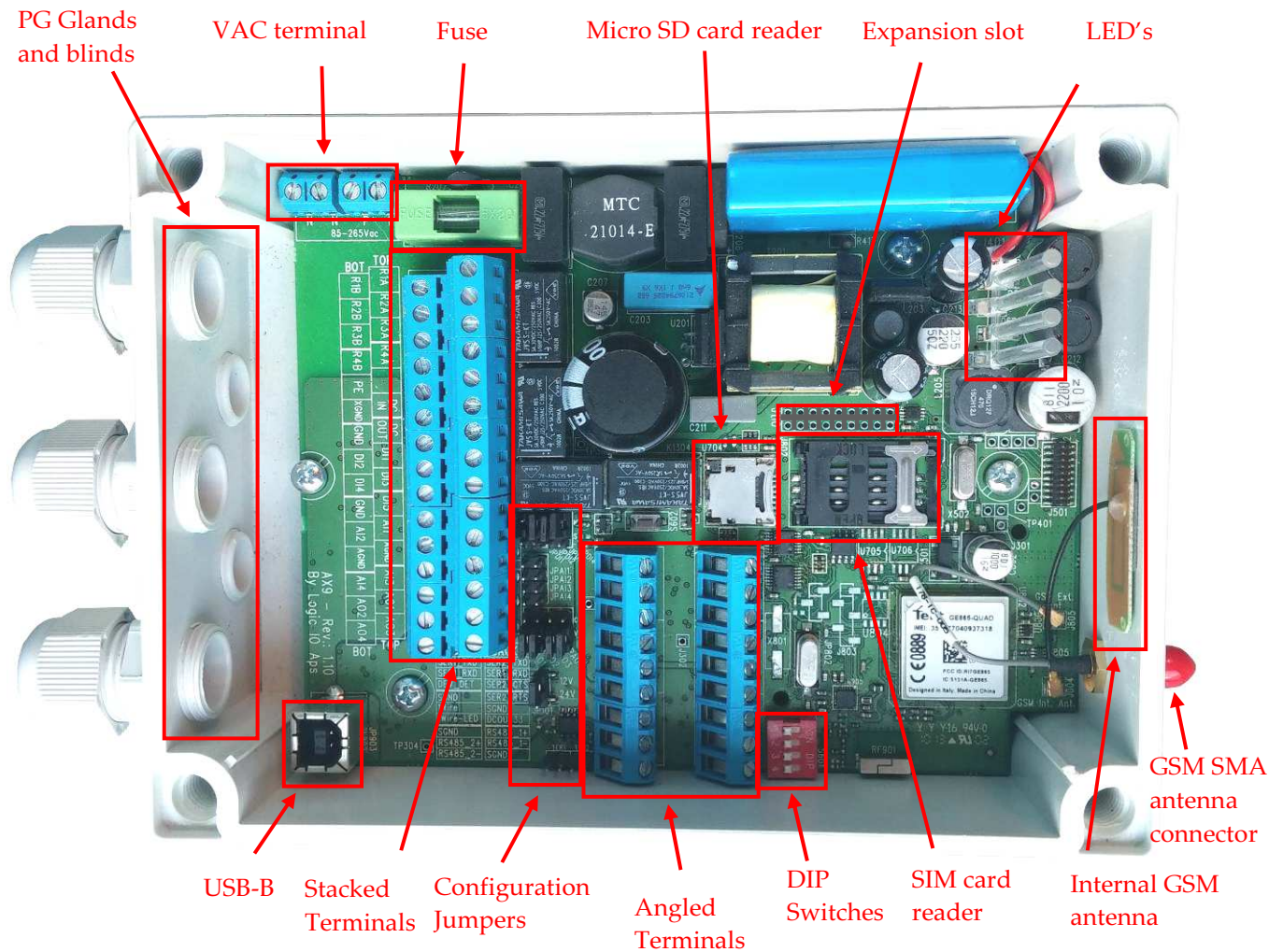

The stacked terminals contain connections for: analog and digital inputs/outputs, 12V/24 DC-Output and DC power input.

The angled terminals contain connections for the communication interfaces: RS232 Port 1, RS232 Port 2, RS485 Port 1, RS485 Port 2, 1-Wire and the +3.3V DC-Output.

Also located inside the M2M Control C450 are the; SIM card reader, Micro SD card reader, DIP switches and a USB-B high-speed programming connector.

Stacked terminal overview

Terminal Name		Description
TOP row	BOT row	
R1A		Contact set for relay output 1
	R1B	
R2A		Contact set for relay output 2
	R2B	
R3A		Contact set for relay output 3
	R3B	
R4A		Contact set for relay output 4
	R4B	
N.C		Not connected
	PE	Protective Earth terminal for AC supply.
DCIN		DC power supply, positive (+) connection
	XGND	DC power ground, negative (-) connection
DCOUT12		12V / 300mA or 24V / 150mA DC output for external equipment
	GND	Signal ground
DI1		Digital input 1 / S0 input 1
	DI2	Digital input 2 / S0 input 2
DI3		Digital input 3 / S0 input 3
	DI4	Digital input 4 / S0 input 4
DI5		Digital input 5 / Wakeup (<i>ignition</i>) input
	GND	Signal ground
AI1		Analog input 1
	AI2	Analog input 2
AGND		Analog ground
	AGND	Analog ground
AI3		Analog input 3
	AI4	Analog input 4
AO1		Analog output 1
	AO2	Analog output 2
AO3		Analog output 3
	AO4	Analog output 4

Angled terminal front row overview

Terminal Name	Description
SER1_TXD	Transmit data from serial port 1, RS232 compatible
SER1_RXD	Receive data for serial port 1, RS232 compatible
DEV_DET	Reserved for accessories.
SGND	Signal ground
1Wire	1-Wire bus
1Wire-LED	1-Wire ID-Button LED output
SGND	Signal ground
RS485_2+	RS485 non-inverting signal for RS485 port 2
RS485_2-	RS485 inverting signal for RS485 port 2

Angled terminal back row overview

Terminal Name	Description
SER2_TXD	Transmit data from serial port 2, RS232 compatible
SER2_RXD	Receive data for serial port 2, RS232 compatible
SER2_CTS	Clear-To-Send for serial port 2, RS232 compatible
SER2_RTS	Request-To-Send for serial port 2, RS232 compatible
SGND	Signal ground
DCOUT33	+3.3V / 300mA DC output for external equipment
RS485_1+	RS485 non-inverting signal for RS485 port 1
RS485_1-	RS485 inverting signal for RS485 port 1
SGND	Signal ground

VAC terminal overview

Terminal Name	Description
N	85-265VAC (50/60Hz) Null input
N	<i>(internally connected)</i>
P	85-265VAC (50/60Hz) Phase input
P	<i>(internally connected)</i>

USB-B connector

This is a standard USB-B connector and is used for communicating with the M2M CONTROL IDE (or other RACP compliant application).

Power supply

The M2M Control C450 unit can be supplied with either 85-265VAC (50/60Hz) or 8-36VDC or both supply types simultaneously.

The M2M Control C450 also contains an internal high capacity backup battery, which will supply the unit if the external power should fail or be disconnected. By default the M2M Control C450 is powered down when a power fail occur. This setting however can be changed. Please consult the M2M Control IDE on-line help for more information.

When the wakeup/ignition input is activated with a logical high, the M2M Control C450 unit will wake up if it was in power down mode.

There are five different ground labels: External Ground (XGND), Signal Ground (SGND), Digital Ground (GND), Analog Ground (AGND) and AC power ground (PE). The signal, digital and analog grounds are filtered from the power ground. External ground must only be used as DC power supply return path. The AC ground is used in order to have a common reference between external AC powered system and the internal system. The digital ground is used as ground reference for digital I/O's, signal ground is used as ground reference for serial interfaces, and the analog ground is used as a low noise analog ground reference for the analog inputs.

Dual Supply Note:

The M2M Control C450 unit can be supplied with both VAC and VDC at the same time. The unit will run on the VAC supply if the VDC supply voltage is $< +16\text{VDC}$. If the VDC supply voltage is higher it will run on the VDC supply.

Please refer to the M2M Control IDE on-line help for information on how to check the supply type from within an application.

DC Supply

The M2M Control C450 unit can be supplied with 8-36VDC from an external DC power source. Positive power is applied to the DCIN pin and ground is connected to the XGND pin.

The DC supply of the M2M Control C450 is protected against wrong polarity. If a system ground are connected to either SGND or AGND a wrong polarity on the supply lines will destroy the internal GND connection.

Please Note:

- Minimum 14VDC supply is necessary for 0-10V analog output configuration.
- Minimum 16VDC supply is necessary for digital inputs 1-4 to work as S0 compliant inputs.

VDC Supply terminals

Terminal Name	Description
DCIN	Power supply, positive (+) connection
XGND	Power ground, negative (-) connection

AC Supply

The M2M Control C450 unit can be supplied with 85-265VAC (50/60Hz) from a standard wall plug or any other high-voltage VAC power rail.

The AC supply of the M2M Control C450 is a high-efficient switch mode power supply and the AC input is protected with a 1A/250V Fast Acting fuse.

The AC must be applied between the **N** and **P** on the separate located screw terminals. Protective Earth (**PE**) connection exists on the bottom row of the stacked terminals.

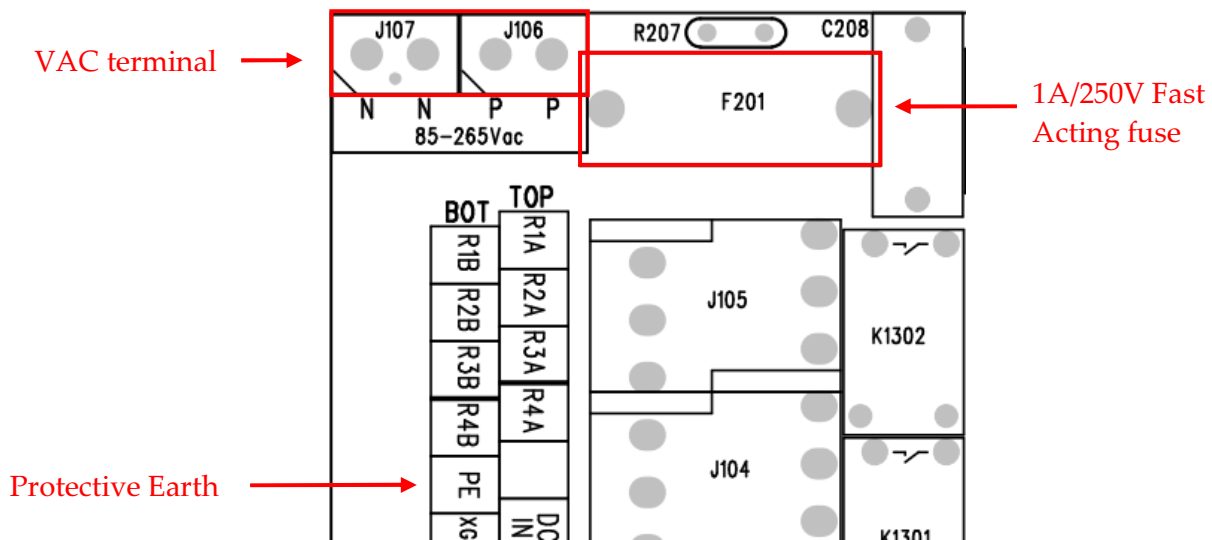

VAC Supply terminals

Terminal Name	Description
N	85-265VAC (50/60Hz) Null input
N	<i>(internally connected)</i>
P	85-265VAC (50/60Hz) Phase input
P	<i>(internally connected)</i>
PE	Protective Earth connector

Please Note:

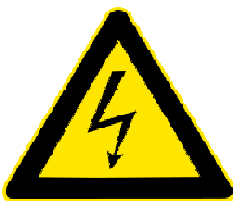

The two pairs of **N** and **P** terminals are internally connected.

There is high voltage on certain areas of the PCB (Printed Circuit Board) when supplied with AC mains. There is risk of electrical hazard, avoid touching the PCB and the components during operation.

Be aware that the supply filter contains capacitors that may remain charged after the equipment is disconnected from the supply. Although the stored energy is within the approved safety requirements, a slight shock may be felt if the plug pins are touched immediately after removal.

Refer all servicing and handling to qualified personnel.

Please Note:

The DC ground of the C450 series is isolated from the AC ground because of the nature of AC-to-DC converting. As these two grounds are not tied together anywhere in the C450, the DC ground may appear as "floating ground" to the outside if the C450 ground is not connected to the same reference as the outside, and a potential difference may occur. This difference can interrupt the behavior of the unit, and in worst case can damage the part of the unit. This must be taken in consideration when the C450 series are supplied with AC supply. When the C450 is supplied with DC voltage this "potential difference" issue may not be observed, as the DC power supply has usually the same potential as the rest of the system.

In order to avoid the potential difference the **Earth** connection on the AC supply rail can be connected to the terminal that has been labeled "PE".

For circuitry in situations where significant Earth ground currents can flow isolating the DC ground from Earth grounds may be desired. In this case the DC ground may be tied together with the Earth ground through a high impedance connection.

In other situations where a common reference needed the best EMI performance and ESD immunity can be achieved connecting the DC ground and Earth ground with a low-inductance connection.

Digital I/O

The M2M Control C450 unit has five digital inputs and four normally-open relay outputs. The outputs are high performance relays with good current handling capabilities.

Digital input 1-4 has several operation modes. Please refer to the digital input section for additional information.

Relay outputs

The digital outputs control four relays and they act like a normally-open contact, where one side must be connected to a source that needs switching and the other contact terminal is the output. The source can be either VAC or VDC but the maximum switchable voltage and current must not be exceeded, please refer to specification page.

There are no internal connections to the relay outputs and therefore a source must always be connected to one of the relay terminals for the output to work. If power is removed or a power-fail occurs on the M2M Control C450 will switch to normally-open.

The M2M Control C450 unit offers a very advanced power management, which makes it possible to have one or more outputs enabled while the unit is in low power mode. Please consult the M2M Control IDE on-line help for more information.

Relay output terminals

Terminal Name	Description
R1A	Contact set for relay output 1
R1B	
R2A	Contact set for relay output 2
R2B	
R3A	Contact set for relay output 3
R3B	
R4A	Contact set for relay output 4
R4B	

Load Noise

If highly inductive loads (such as high power contactors) are connected to the relays it is recommended to externally connect a clamping diode in parallel with each inductive DC load or connect an RC snubber circuit in parallel with each inductive AC load.

For DC applications Vishay UF5405-E3/54 or similar is recommended and for AC applications AMPOHM FE-SP-HDR23-47/100 (47nF/100 ohm) or similar is recommended.

Digital inputs / S0 inputs / wakeup (*ignition*) input

The five digital inputs are all low-pass filtered (*450kHz*) and transient-protected. To activate the inputs, connect a positive voltage between the corresponding input (DINx) and SGND.

Digital input 1-4 can be configured individually as S0 input (*IEC62053-31, Class A*) and DIN5 can work as a wakeup (*ignition*) input.

As default the digital inputs are configured as normal inputs. For placement and configuration of the hardware jumpers inside the unit, please refer to the configuration guide in Appendix A.

S0 compliant inputs (*IEC62053-31, Class A compatible*)

In S0 configuration the relevant M2M Control C450 input will act as a 'pulse input device', and a current is supplied into the input connector so that a simple switch between SGND and the appropriate input will activate it. This is used in most electricity metering equipment.

Please note: The M2M Control C450 unit must be supplied with a minimum of 16 VDC or AC power for the S0 mode to work correctly.

S0 must also be enabled from the application in order to work as an S0 compliant input.

Wakeup (*ignition*) input

The DI5 / Wakeup (*ignition*) input is a special input as it also functions as the wakeup input. If the input is activated with a logical high or low (Wait-For-Event mode only) when the M2M Control C450 is in low power mode it will wakeup the unit. A power apply will also wake the unit up if it is in power-down mode or in Wait-For-Event mode with power Apply and/or ignition selected for wakeup.

The input is de-bounced with a period between 1-2 ms when used as a digital input. So any logical level applied to this input must be greater than 2 ms to be valid.

The power management allows the possibility to configure a wakeup on one or more digital inputs with individually configured falling- or rising edge detection. Please consult the M2M CONTROL IDE on-line help for more information.

For placement and configuration of the hardware jumpers inside the unit, please refer to the unit configuration guide in Appendix A.

Digital input terminals

Terminal Name	Description	Jumper Setting
DI1	Digital input 1 or S0 input 1	JPDI1 in position N (<i>default</i>) JPDI1 in position S
DI2	Digital input 2 or S0 input 2	JPDI2 in position N (<i>default</i>) JPDI2 in position S
DI3	Digital input 3 or S0 input 3	JPDI3 in position N (<i>default</i>) JPDI3 in position S
DI4	Digital input 4 or S0 input 4	JPDI4 in position N (<i>default</i>) JPDI4 in position S
DI5	Digital input 5 and Wakeup (<i>ignition</i>) input	
GND	Digital Ground	

Specification for each normal digital input

	Min.	Typ.	Max.	Unit	
Logic "High"	8	12	40	VDC	Protected against transients and low-pass filtered
Logic "Low"	-5	-	3	VDC	
Cut-off frequency	-	450	-	kHz	
Input impedance	-	14	-	k Ω	

Analog I/O

Analog inputs

The M2M Control C450 unit has four analog inputs which can be configured individually to work either as voltage or current measurement inputs by using the configuration jumper. The range in voltage mode is 0-10VDC and in current mode it is 0-20mA.

The conversion resolution is 12 bit.

By default the analog inputs are configured as voltage inputs, and are converted to a digital value with a resolution of 10-bit before being presented to the application (0..1023). The application can change the resolution to the full 12 bit (0..4095). Please consult the M2M CONTROL IDE for further details.

The input signal is connected between AINx and AGND. AGND must be connected to the reference of the connected equipment. Please be aware that deviations may occur, as the system is very noise sensitive. Avoid long, unshielded wires and high current, fast changing signals routed parallel to the analog signals.

The inputs are low-pass filtered, ESD- and transient protected.

As default the inputs are configured as voltage inputs. For placement and configuration of the hardware jumpers inside the unit, please refer to the unit configuration guide in Appendix A.

Analog input terminals

Terminal Name	Description	Jumper Setting
AI1	Analog input 1 – Voltage	JPAI1 not installed (<i>default</i>)
	Analog input 1 – Current	JPAI1 installed
AI2	Analog input 2 – Voltage	JPAI2 not installed (<i>default</i>)
	Analog input 2 – Current	JPAI2 installed
AI3	Analog input 3 – Voltage	JPAI3 not installed (<i>default</i>)
	Analog input 3 – Current	JPAI3 installed
AI4	Analog input 4 – Voltage	JPAI4 not installed (<i>default</i>)
	Analog input 4 – Current	JPAI4 installed
AGND	Analog ground	
AGND	Analog ground	

Specification for each analog input (voltage mode)

	Min.	Typ.	Max.	Unit	
	0	-	10	VDC	Protected against transients and
Resolution	-	-	12	Bit	low-pass filtered
Precision	-1.5	-	1.5	%FSR	Precision is based on
Cut-off frequency	-	4.5	-	kHz	measurements @ 25 °C
Input impedance	-	40	-	k Ω	

Specification for each analog input (current mode)

	Min.	Typ.	Max.	Unit	
	0	-	20	mA	Protected against transients and
Resolution	-	-	12	Bit	low-pass filtered
Precision	-1.5	-	1.5	%FSR	Precision is based on
Cut-off frequency	-	4.5	-	kHz	measurements @ 25 °C
Input impedance	-	504	-	Ω	

Analog outputs

The analog outputs can individually be configured to work either as voltage or current outputs. The range in voltage mode is 0-10VDC and in current mode it is 0-20mA. The resolution of the digital-to-analog converter is 10bit or 1024 in decimal scale.

The decimal value for 10V/20mA output are 1023 and 512 for 5V/10mA.

As default the outputs are configured as voltage outputs. For placement and configuration of the hardware jumpers inside the unit, please refer to the unit configuration guide in Appendix A.

The output signal is connected to external equipment between AOUTx and AGND. AGND must be connected to the reference of the connected equipment. Please be aware that deviations may occur, as the system is very noise sensitive. Avoid long unshielded wires and large fast-changing signals routed parallel to the analog signals. In current mode the specifications for the analog output only valid if the load is maximal 250Ω.

Each output is ESD and transient protected.

Please note: The M2M Control C450 unit must be supplied with minimum 14 VDC or AC in order for the analog outputs to work according to specifications.

Analog output terminals

Terminal Name	Description	Jumper Setting
AO1	Analog output 1 – Voltage	JPAO1 in position V (<i>default</i>)
	Analog output 1 – Current	JPAO1 in position C
AO2	Analog output 2 – Voltage	JPAO2 in position V (<i>default</i>)
	Analog output 2 – Current	JPAO2 in position C
AO3	Analog output 3 – Voltage	JPAO3 in position V (<i>default</i>)
	Analog output 3 – Current	JPAO3 in position C
AO4	Analog output 4 – Voltage	JPAO4 in position V (<i>default</i>)
	Analog output 4 – Current	JPAO4 in position C
AGND	Analog ground	
AGND	Analog ground	

USB programming port

The USB port is for programming and communicating with the M2M CONTROL IDE (or other RACP compliant application). A standard USB cable can be used between the unit and the PC.

RS232 communication ports (EIA/TIA-232 and V.28/V.24 compatible)

Two general purpose RS232 ports available on the M2M Control C450 unit. Both are compliant with the EIA/TIA-232 standard.

RS232 port 1

This port is a general-purpose RS232 serial port and does not support handshaking. This serial port shares resources with the RS485 port 2 and only one of them can be active at a given time.

The signals are available on the angled front row terminals.

SER1 terminals

Terminal Name	Description
SER1_TXD	Transmit data from serial port 1, RS232 compatible
SER1_RXD	Receive data for serial port 1, RS232 compatible
SGND	Signal ground

RS232 port 2

Serial port 2 is a general-purpose RS232 port with RTS/CTS handshaking signals present.

The signals are available on the angled back row terminals.

SER2 terminals

Terminal Name	Description
SER2_TXD	Transmit data from serial port 2, RS232 compatible
SER2_RXD	Receive data for serial port 2, RS232 compatible
SER2_CTS	Clear-To-Send
SER2_RTS	Request-To-Send
SGND	Signal ground

RS485 communication ports (EIA/TIA-485-A compatible)

RS485 is a multi-drop network with a maximum of 32 units connected simultaneously to the bus. The RS485 bus contains an RS485+ (*non-inverting*) and an RS485- (*inverting*) signal as well as a signal ground which must always be connected to the common signal ground for all units connected to the RS485 bus!

The maximum cable length for the RS485 bus is according to the EIA/TIA-485-A standard (max. 1200m @ <100kbit); this limit is highly influenced by the quality of the cable, signaling rate, noise etc.

At longer cable lengths, noisy environments, or high communication speeds, it might be necessary to terminate the transmission line with a 120¹ ohm resistor at each end of the transmission line to terminate it and avoid signal reflections.

When the M2M Control C450 is used as endpoint unit the hardware jumper TER1 and TER2 can be installed to terminate the RS485 communication lines with 120Ω.

Both RS485 ports can be used as general-purpose RS485 serial port or as I/O extension module(s) port. When used with supported MODBUS IO extension modules, general purpose use is disabled. The RS485 port signals are available on the angled terminals.

Further details on the MODBUS I/O extension modules and use are available in the M2M CONTROL IDE on-line help.

By default the RS485 communication lines are not terminated with 120 Ω. For placement and configuration of the hardware jumpers inside the unit, please refer to the configuration guide in Appendix A.

¹ Assuming use of a CAT5 twisted pair cable

RS485 port 1

RS485 signals are available on the angled back terminals.

If TER1 jumper is inserted a 120Ω endpoint resistor is enabled, for location of TER1 refer to Appendix A

RS485 port 1 terminals

Terminal Name	Description
RS485_1+	RS485 non-inverting signal for RS485 port 1
RS485_1-	RS485 inverting signal for RS485 port 1
SGND	Signal ground

This RS485 port must be addressed as **port 2** when using the VPL API, such as the serOpen function.

RS485 port 2

The RS485 port is available on the angled front terminals.

Internally this RS485 port and the RS232 serial port 1 shares the same signals and only one can be active at any given time.

If TER2 jumper is inserted a 120Ω endpoint resistor is enabled, for location of TER2 refer to Appendix A

RS485 port 2 terminals

Terminal Name	Description
RS485_2+	RS485 non-inverting signal (A)
RS485_2-	RS485 inverting signal (B)
SGND	Signal ground

This RS485 port must be addressed as **port 0** when using the VPL API, such as the serOpen function.

1-Wire

The 1-Wire bus is available on the angled front row terminals. All 1-Wire communication goes through a single connection, and all 1-Wire devices connected to this connection retrieves its power directly from the bus (called parasitic power). For this only two wires are needed – the 1-wire signal and the ground reference – allowing minimal cable installations.

For 1-Wire ID-Button readers, which include a built-in LED, a dedicated output is available for this purpose. Please consult the M2M CONTROL IDE documentation for further information.

1-Wire terminals

Name	Description
1Wire	1-Wire bus
1Wire-LED	1-Wire ID-Button LED output
SGND	Signal ground

DC-Out

Two DC outputs are available on the M2M Control C450 for supplying external equipment; a 3.3V and a 12V/24V output. It is possible to control these DC outputs in order to save power. Both DC outputs are short circuit- (to ground), ESD- and transient protected.

Make sure not exceed the current specification of the outputs and be aware of inrush currents of the external equipment may exceed the specifications.

The DC outputs must be enabled from the application. Please consult the M2M CONTROL IDE on-line manual for more information.

3.3V DC-Out

The +3.3V DC output can supply a maximum of 300mA and is available on the angled back row terminals. This output is named boardDCOut in the M2M Control IDE online help.

12V/24V DC-Out

Using the jumper JP101 either 12V or 24 DC are available on the DC-out terminal. The 12V DC output can supply a maximum of 300mA, and the 24V DC output can supply a maximum of 150mA. The DC-Out is available on the top row of the stacked terminals. This output is named boardDCOut2 in the M2M Control IDE online help.

Please note that the 12V DC-out voltage requires whether a DC supply voltage of minimum 13V or the AC supply is present, while the 24V DC-out voltage requires that the AC supply is present.

The jumper that switches the DC-out voltage level between 12V DC and 24V DC is located front of the communication terminal rows as shown below:

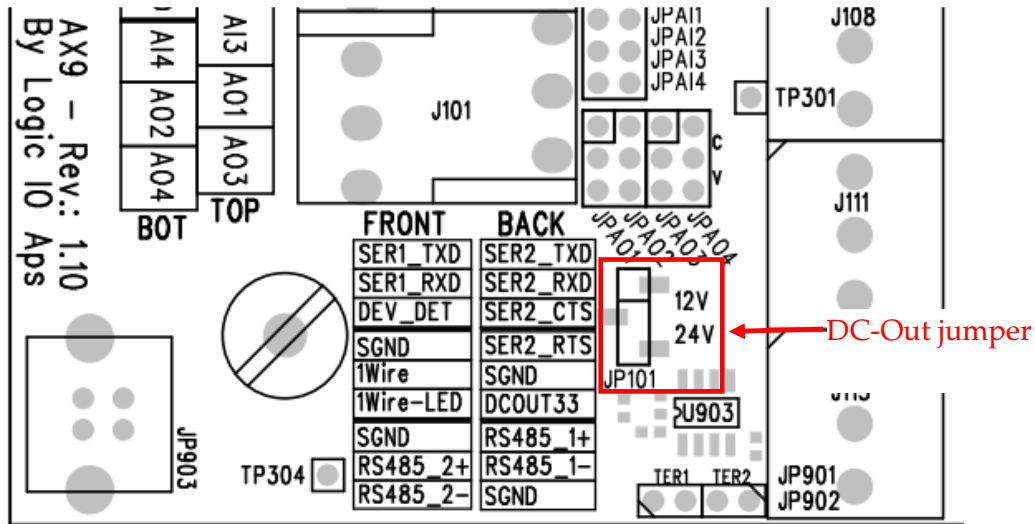

Please note that both 12V and 24V outputs are **not** short-circuit protected

DC-Out terminals

Terminal Name	Description
DCOUT33	+3.3V / 300mA DC output for external equipment.
DCOUT	+12V/300mA / +24V/150mA DC output for external equipment.
SGND	Signal ground

LED Indicators

Three bi-colored (red and green) and a single yellow LED indicator are present on the front of the unit (see graphical view).

Two bi-colored LED's (A and B) are available to the user and the remaining two LED's (S1 and S2) are signaling the status and possible errors of the unit.

User LED A and B

LED A and B are composed of four individually controllable LEDs:

- LED named A on the front consists of LED 1 (green) and LED 2 (red).
- LED named B on the front consists of LED 3 (green) and LED 4 (red).

They are easily accessed from within the application program, and it is possible to mix the LED's to obtain a third color: yellow. Please consult the M2M CONTROL IDE documentation for more information.

System LED S1 and S2

The C450 is equipped with two system LED's which shows the status and possible errors of the unit.

The different patterns are listed in the table below. If the color of the system LED S1 is yellow, the unit is actively communicating with the M2M Control IDE (or another program, supporting the RTCU RACP protocol).

The single yellow LED is signaling either the GSM module activity, or if all other LED's are off, that the unit is in the "wait for event" low power state.

S1: System LED1 pattern overview

Pattern	Description
Fastest blinking, green	The unit is initializing, preparing to start the application.
Fast blinking, green ¹	The unit has been forced into recovery mode with the use of the system switch. The application is not executing.
500ms On / 500ms Off green ¹	The unit is executing the application program
1.5s On / 0.5s Off. green ¹	The unit is executing the application program, while charging the internal back-up battery.
Fast blinking, red ¹	A runtime error has been detected in the program. Use the M2M Control IDE to obtain the fault log.
Alternating Fast/Slow, red ¹	The unit has lost its firmware! This can only happen if, during a firmware upgrade, the C450 unit loses power or the communication is lost completely. In this case, simply upload the firmware to the unit again.
75ms On / 925ms Off, green	Execution speed is different from full-speed.

S2: System LED2 pattern overview (GSM activity and "Wait For Event")

Pattern	Operating Status
Off	The GSM module is turned off
600 ms On / 600 ms Off	Missing SIM card or PIN code. Network search and logon in progress.
75 ms On / 3 s Off	Logged on to the network.
75 ms On / 75 ms Off / 75 ms On / 3 s OFF	A GPRS session is active.
Flashing	Indicates GPRS data transfer.
On	A voice or CSD session is active.
8 s OFF / 10 ms ON (and all other LED's OFF)	The C450 unit is in low-power "Wait For Event" state.

¹ Or yellow when communicating with the M2M Control IDE or another program, supporting the RTCU RACP protocol).

Switches

DIP-Switch

The M2M Control C450 unit contains four dipswitches, where three of them are available for the application to use (*fourth dipswitch is reserved for GSM antenna switching.*) The dipswitches are located inside the unit (*see drawing below or graphical view*)

System switch (RST)

The M2M Control C450 unit contains a combined reset/diagnostic switch. This switch is accessible from the front of the unit (*see graphical view*) It is necessary to use a small thin object with a diameter of approx. 2 mm, for example a straightened-out paper clip for this purpose.

By activating the switch shortly the C450 will do a complete reset, as if the power was removed and reapplied.

If the reset switch is held down for approx. 3 seconds¹ the unit will enter recovery mode² where the application will not be started. In recovery mode the system will automatically turn on the GSM module to establish a connection to the GSM network and M2M Control GPRS Gateway (if configured). This method will also activate the unit when the unit is in power-down mode.

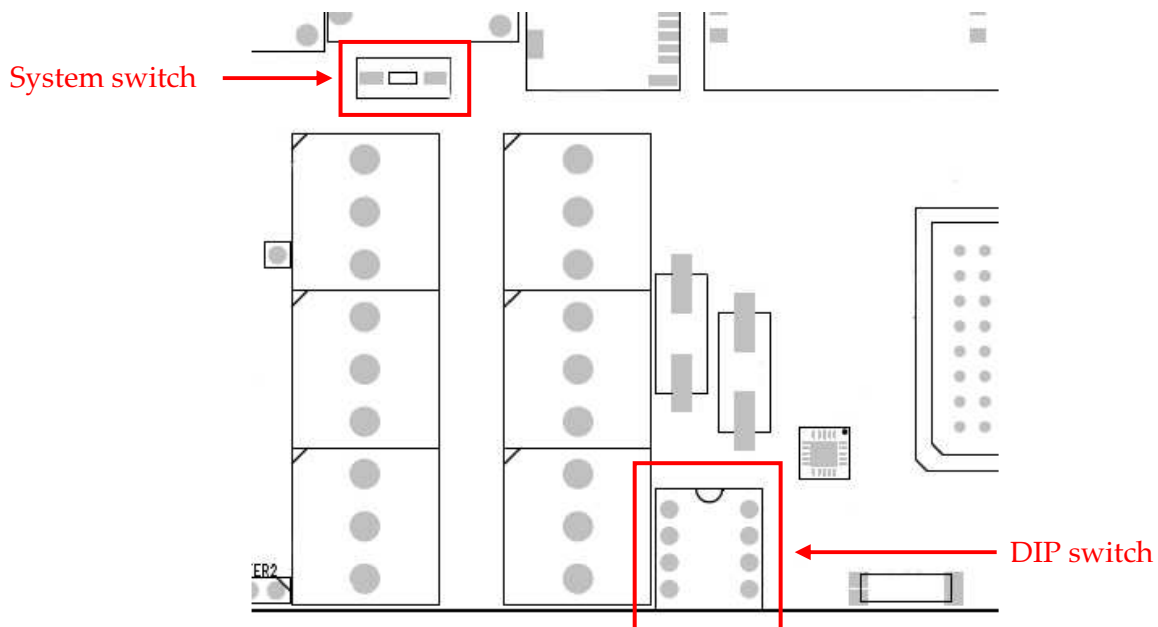

¹ System LED S2 will flash three times when this state is entered.

² System LED S1 will indicates this state by fast blinking green or yellow.

Internal Li-Ion battery

The C450 contains an internal Li-Ion battery for operation even when the external power is absent making it possible to report power loss etc. Please note that when external power is removed, the unit will be powered down by default. This setting can be changed as documented in the M2M CONTROL IDE documentation.

The relay outputs will be disabled when a power fail occurs as the internal battery cannot provide the supply voltage needed.

The battery charging is completely automated and handled internally by the C450 – leaving no need for user interaction. Different kinds of functions (Battery low, Charger enable, Charging status, etc.) are available to the user application.

The charge current is relatively high, for a shorter charge time, as specified in the technical specification. Make sure both power supply and cables can handle the high current.

The battery will be charged whenever a power fail has occurred to establish the capacity thus making the battery ready for the next power fail. A maintenance charge will start every 20 days after the last charge. This is to compensate for the battery self-discharge etc.

By default the battery cannot be charged above 45°C or below 0°C. The C450 offers charging down to -10 °C using a specialized algorithm to protect the battery.

If the temperature is above 45°C the charging will not start and will be postponed until it is below this threshold.

The temperature has a very high influence on the battery capacity. At 0°C the capacity has dropped to 60% of the initial capacity and it falls dramatically at lower temperatures.

The battery cycle (numbers of charges and discharges) also influences the capacity. After 300 cycles the capacity has dropped to approximately 80% of the initial capacity.

Warning

Misusing the C450 unit may cause the built-in battery security circuit to be damaged.

- *Do not place the C450 in high temperature locations such as in direct sunlight or near engines. Using the C450 in this environment may result in loss of battery performance and a shortened life expectancy.*
- *Do not expose the unit to water, salt water or allow the battery to get wet.*
- *Avoid strong impacts and shocks.*

For more information regarding the environmental limitations see specification page or consult the M2M Control C450 Datasheet.

GSM

For GSM and GPRS communication an industry leading QUAD band (850/900/1800/ 1900MHz) GSM module is used.

The M2M Control C450 supports:

- Digitized voice
- SMS (Text and PDU)
- GPRS Multislot class 10. Support for simultaneous Voice and GPRS (suspended)
- CSD (Datacall)

GSM Antenna

The M2M Control C450 offers support for both an on-board internal GSM antenna and a user supplied external antenna connected to the SMA female connector at the top of the encapsulation.

The active antenna can be selected by the application using the `gsmSetAntennaMode` function or alternatively with a DIP switch. By default when the unit is delivered the active antenna can be selected by DIP switch 4 and is set for external antenna.

Location of the internal/external GSM antenna and the DIP-switch 4:

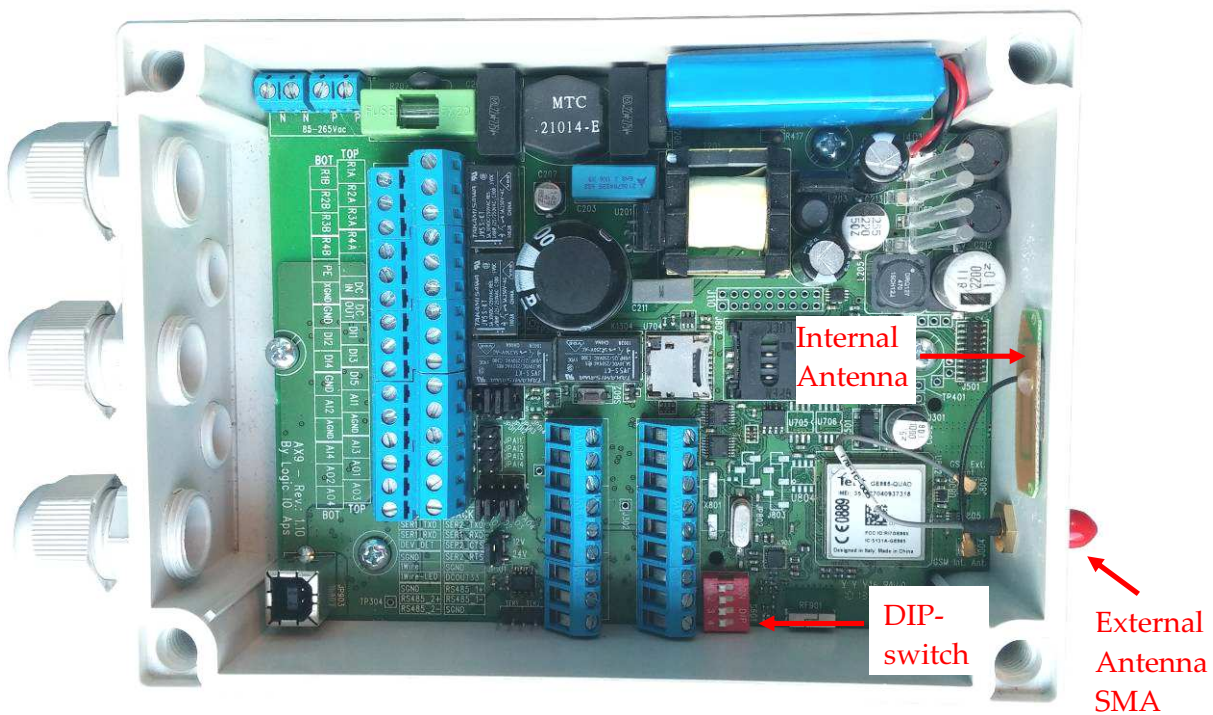

GSM antenna selection

gsmAntennaMode	DIP-switch 4	GSM Antenna
1	Ignored	Internal antenna
2	Ignored	External antenna
3	On	Internal antenna
	Off	External antenna

Please refer to the M2M CONTROL IDE online help for further information on **gsmSetAntennaMode**

When installing the M2M Control C450 please make sure that the antenna is not in close proximity of metallic parts or anything else that can influence the efficiency of the GSM antenna.

SIM-Card

The M2M Control C450 unit contains a standard SIM card reader which is located inside the unit (*see drawing on next page or graphical view*) and is easily accessed. The SIM card reader is lid based with a mechanical lock system for secure installation of the SIM card. Please refer to Appendix B for SIM card installation guide.

Micro SD card reader

The M2M Control C450 unit has a standard Micro SD card reader which is located inside the unit (see drawing below or graphical view). The Micro SD card reader is a lid based system with mechanical lock for reliable insertion and operation.

The M2M Control C450 supports a FAT file-system for standard PC-compatibility. Up to 32 GByte capacity is supported. Please refer to Appendix C for SD-Card installation guide.

Both the card detect and the write protect¹ information is available to the user through the application. Please consult the M2M CONTROL IDE on-line help for more information. Avoid removing the Micro SD card during access to the card.

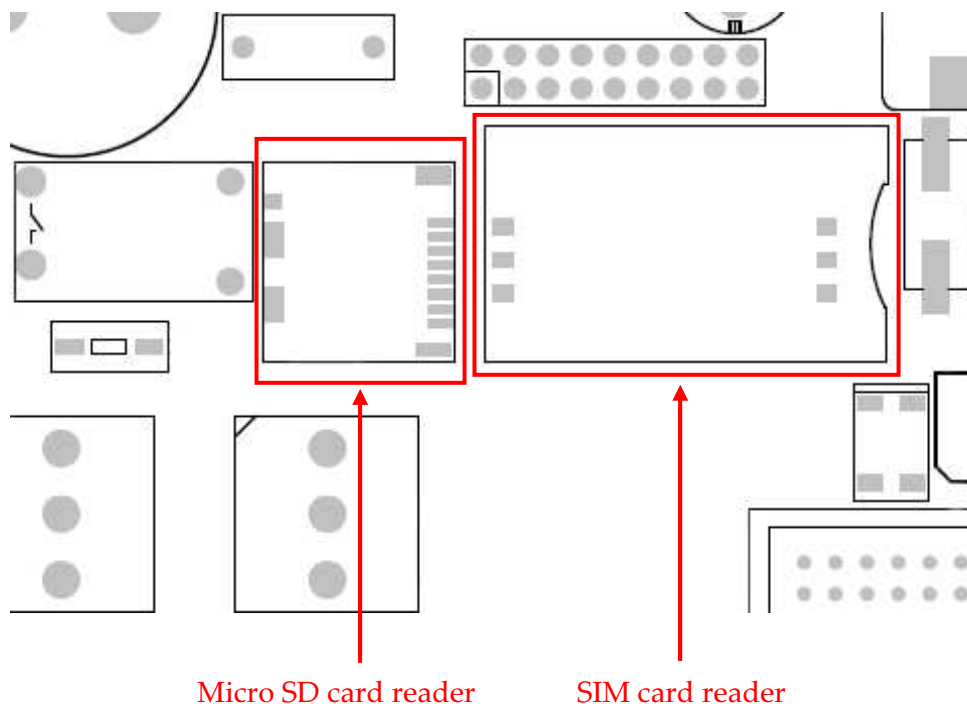

¹ This signal is not available, but for compatibility reason the software function will always return “not write protected”.

Approved Micro SD cards

To ensure the highest performance and compatibility it is important to use SD-CARDS that has been approved and tested by M2M Control.

The following **Commercial Grade** micro SD-CARDS from Sandisk has been approved for use:

Capacity	Sandisk SKU
4GB	SDSDQM-004G-B35
8GB	SDSDQM-008G-B35
16GB	SDSDQM-016G-B35
32GB	SDSDQM-032G-B35

Commercial grade SD-CARDS can be used in applications where the limited write endurance is acceptable - for example if the SD-CARD is often replaced. Commercial grade SD-CARDS should *not* be used in applications where a potential failure on the media is considered mission critical.

For applications that uses the SD-CARD media extensively and where a failure is critical, it is recommended to use approved **Industrial Grade** SD-CARDS.

M2M Control has approved and recommends industrial grade SD-CARDS from ATP that is available in capacities from 512 MB to 32 GB.

ATP Industrial Grade SD/SDHC Cards are optimized for demanding industrial applications with consistent performance in all conditions. ATP uses reliable SLC flash technology with a flash endurance more than 20 times higher than commercial grade products with MLC flash.

The differences in write endurance between commercial grade MLC flash and ATP Industrial grade SLC flash are quite remarkable for write-intensive applications:

Product Line	Details	Total Writeable Data Prediction @ 1GB	Time Prediction @ 500 writes a day (1GB)
ATP Industrial Grade	SLC Flash	80,000GB	5,740 days
	+ Advanced Wear Leveling	or 2,800,000 writes	or 15.7 years
Commercial Grade	Grade A MLC (2 bits per cell)	4,000GB	280 days
	+ Advanced Wear Leveling	or 140,000 writes	

ISM RF

The M2M Control C450 is provided with an ISM band RF module, which gives the unit ability of communicating with other devices wireless. The unit communicates in the 868 MHz frequency band. The RF module hardware is setup to comply with the European EN 300 220 requirements. Please consult the M2M CONTROL IDE on-line help for more information on how to configure the RF module.

In the table below the specifications of the RF module is shown:

RF module specifications

Data	Value
Max. Output Power	+10 dBm
Frequency	869,4 MHz
Modulation	GFSK
Baud Rate	38,4 kbaud

Please Note: Listen Before Talk (LBT)¹ functionality to comply with EN 300 220 is implemented in the RF module. If the unit is installed in an environment with disturbance in the same frequency band, difficulties in RF transmission will be observed.

Barcode / unit type

The barcode label found on the M2M Control C450 unit contains the serial number.

The first three digits in the serial-number identify the unit type, and for M2M Control C450 this unique code is **269**.

The barcode format used: 2/5 Interleaved with Check Digit

¹ LBT is a term used in radio communication whereby a radio transmitter senses its radio environment before it starts a transmission

Power consumption

Detailed information on the maximum power consumption of the M2M Control C450 unit in different states and different supply types is listed below.

Please Note: Values marked with (*) is average and should be considered as guidelines as they may vary depending on the GSM signal strength.

External DC supply

When the M2M Control C450 unit is powered from an external DC power source the power consumptions will be as follows.

Maximum power consumption

	8V	12V	30V		
Unit active	65	50	20	mA	
Unit active with GSM on*	80	60	25	mA	GSM idle @ -67dBm*
Unit active RF sending	65	55	20	mA	
Unit active while charging	870	530	290	mA	
Unit in power-down	1.3	0.8	0.4	mA	Restart on DIN5, RTC
Unit in "wait for event"	1.3	0.8	0.4	mA	Resume on DIN, RTC
Unit in "wait for event"	10	6	3	mA	Resume on RS232
Unit in "wait for event"	26	20	8	mA	Resume on GSM activity

Internal battery

If the external power source is removed and the internal battery is enabled the power consumption from the battery will be as listed below.

Maximum power consumption

	BAT		
Unit active	85	mA	
Unit active with GSM on*	105	mA	GSM idle @ -67dBm*
Unit in power-down	1.5	mA	Restart on DIN5, RTC
Unit in "wait for event"	1.5	mA	Resume on DIN, RTC
Unit in "wait for event"	12	mA	Resume on RS232
Unit in "wait for event"	35	mA	Resume on GSM activity

Note: Power consumption from a fully charged battery.

External AC supply

When the M2M Control C450 unit is powered from an external AC the power consumptions will be as follows.

Maximum power consumption

	220VAC		
Unit active	8	VA	
Unit active with GSM on*	8.5	VA	GSM idle @ -67dBm*
Unit active RF sending	8.3	VA	
Unit active while charging	17.2	VA	
Unit in power-down	6.6	VA	Restart on DIN5, RTC
Unit in "wait for event"	6.6	VA	Resume on DIN, RTC
Unit in "wait for event"	7	VA	Resume on RS232
Unit in "wait for event"	7	VA	Resume on GSM activity

Appendix A – Unit configuration guide

The M2M Control C450 has many features and some of them require configuration by using hardware jumpers inside the unit. A brief overview over the jumper settings can be found in the following table.

Feature	Jumper	State	Default state
Communication	TER1 (RS485_1)	Installed	120Ω resistor enabled
		Not installed	120Ω resistor disabled (<i>default</i>)
	TER2 (RS485_2)	Installed	120Ω resistor enabled
		Not installed	120Ω resistor disabled (<i>default</i>)
Analog input	JPAI1	Installed	AI1 current measurement
		Not installed	AI1 voltage measurement (<i>default</i>)
	JPAI2	Installed	AI2 current measurement
		Not installed	AI2 voltage measurement (<i>default</i>)
JPAI3	Installed	AI3 current measurement	
	Not installed	AI3 voltage measurement (<i>default</i>)	
JPAI4	Installed	AI4 current measurement	
	Not installed	AI4 voltage measurement (<i>default</i>)	
Analog output	JPAO1	Position C	AO1 current
		Position V	AO1 voltage (<i>default</i>)
	JPAO2	Position C	AO2 current
		Position V	AO2 voltage (<i>default</i>)
JPAO3	Position C	AO3 current	
	Position V	AO3 voltage (<i>default</i>)	
JPAO4	Position C	AO4 current	
	Position V	AO4 voltage (<i>default</i>)	
Digital input	JPDI1	Position S	DI1 S0
		Position N	DI1 normal (<i>default</i>)
	JPDI2	Position S	DI2 S0
		Position N	DI2 normal (<i>default</i>)
JPDI3	Position S	DI3 S0	
	Position N	DI3 normal (<i>default</i>)	
JPDI4	Position S	DI4 S0	
	Position N	DI4 normal (<i>default</i>)	
DC-Out voltage	JP101	Position 12V	12V DC out
		Position 24V	24V DC out

TER1 and TER2

Enables/disables on-board 120Ω line termination resistors which are according to standards; RS485 communication requires a proper line termination value (120Ω *assuming a CAT5 twisted pair cable is used*) resistors in both ends of the bus. If the M2M Control C450 unit is used as endpoint the relevant jumper can be installed.

JPAI1, JPAI2, JPAI3 and JPAI4

These jumpers are used to select between current and voltage input. With a jumper installed on the relevant analog input it will measure current between 0-20mA.

JPAO1, JPAO2, JPAO3 and JPAO4

These jumpers are used to select either current or voltage output. With the relevant jumper installed in position "C" the output is a current between 0-20mA, when installed in position "V" output is a voltage between 0-10V.

JPDI1, JPDI2, JPDI3 and JPDI4

These select either normal or Class A S0 input for DIN1-4. With the relevant jumper installed in position "S" the input is configured to S0, when installed in position "N" the input is a normal digital input.

The following figure shows the location of the jumpers when the lid of the unit is removed. Red lined boxes show default state of the jumpers.

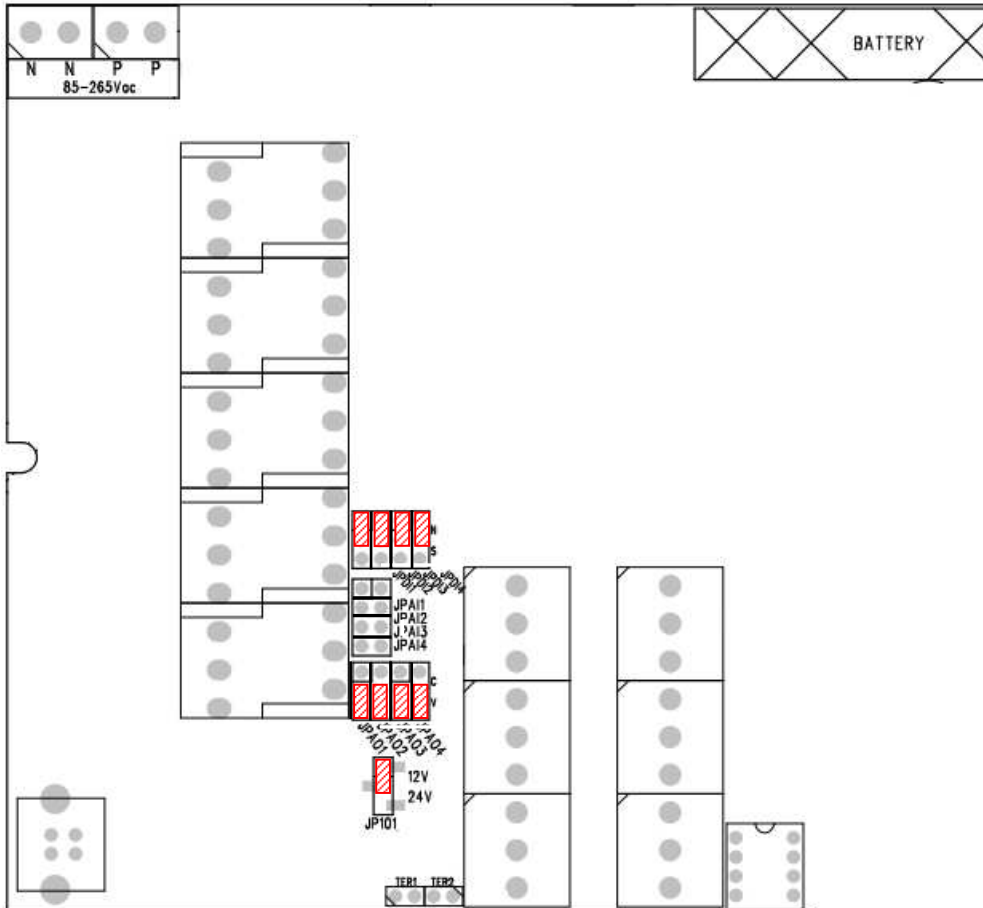

Appendix B – Installing the SIM card

The SIM card reader is a lid based type with a mechanical lock for secure installation of the SIM card.

Open the hinged lid of the SIM card reader, orientate the card as showed below, and insert it into the lid of the card reader. Close the lid, and slide the metal locking mechanism to the locked position as shown with an arrow and text on the lid, until a click is heard.

To remove the card slide the metal locking mechanism to the unlocked position as shown with an arrow and text on the lid, and open the lid. The SIM card can now be removed.

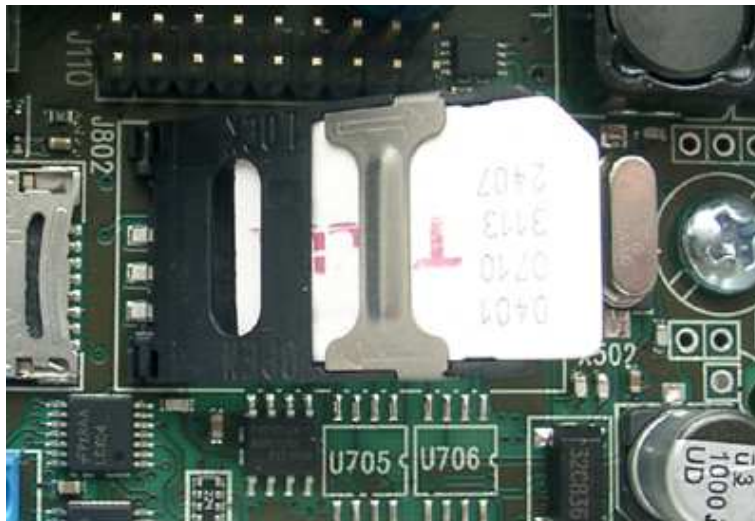

SIM card orientation.

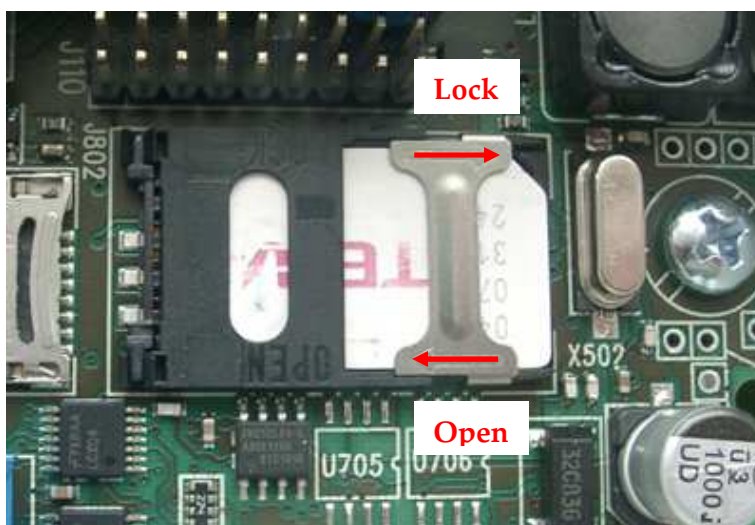

SIM inserted and locked

Appendix C – Installing the Micro SD card

To insert a Micro SD card into the reader open the hinged lid of the card reader, orientate it as shown below, and push the card into the lid. Close the lid, and slide the metal lid in the direction that is shown with an arrow on the lid, until a click is heard.

Remove the card by sliding the lid in the direction that is shown with an arrow on the lid, and then open the lid. Avoid removing the Micro SD card during access to the card.



Micro SD card orientation

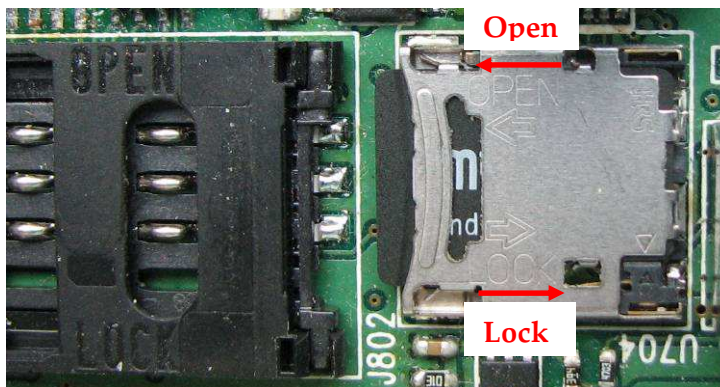

Micro SD card inserted and locked

M2M Control C450 Specifications

Processor and Main-memory

- Powerful 32-bit ST ARM7 processor.
- 1088 KB fast execution RAM.
- 2304 KB Flash for firmware/ application.

Storage

- 3.5 MB persistent data flash.
- 4 MB internal FAT32 flash drive.
- 1 MB circular automatic datalogger.
- 8 KB FRAM with fast access / unlimited write endurance.
- Micro SD-CARD reader. Up to 32 GB.

GSM

- Quad-band GSM engine. 850/900/1800/1900 MHz.
- GPRS Class B, Multislot 10.
- CSD with up to 19 Kbps.
- SMS / PDU.
- DTMF decoding / transmission.
- Digitized voice playback / IVR.
- Micro-SIM 1.8/3 volt.
- Internal SIM card-reader.
- Internal quad-band GSM antenna.
- External or internal antenna selectable by DIP-switch or user application.
- Optional Gemalto SIM-on-chip.

User Interaction

- Three bi-colour LED.
- Yellow status LED.
- DIP-switches.
- Reset/ recovery switch.
- Antenna selection dip-switch.
- Configuration jumpers.
- USB-B for service port.

Battery and Charger

- On-board 2Ah (nominal) Li-Ion battery.
- Intelligent charger with temperature throttle and sub-zero degrees support.
- On-board temperature sensor.

Digital/ Analog Interface

- 4 x relay output.
Max. 5A @250VAC / 30 VDC
- 5 x digital inputs.
Logic high: 6 to 40 VDC.
Logic low: -5 to 3 VDC.
- 4 x IEC62053-31 Class A input.
- Digital input #5 can be used as ignition.
- 4 x analog inputs.
Range is 0..10VDC or 0..20 mA
Resolution: 12 bit
Precision: $\pm 1.5\%$ FSR @25°C
- 4 x analog outputs.
Range is 0..10VDC or 0..20 mA
Resolution: 10 bit
Precision: $\pm 1.5\%$ FSR @25°C
- Protected against transients and low-pass filtered.
- Expandable I/O with MODBUS.

Communication

- 1 x RS232 with control signals.
- 1 x RS485.
- 1 x shared RS232 / RS485.
- 1-Wire bus.
- On-board 868 Mhz ISM RF
Up to 15 meter indoor /
Up to 50 meter outdoor.
- ISM RF can be disabled for world-wide compliance requirements.

Internal Interfaces.

- Screw-terminals for:
Power, I/O and 12/24V DCOUT.
- Angled screw-terminals for:
RS232, RS485, 1-Wire and
3.3V DCOUT.

External Interfaces.

- SMA Female connector for external GSM antenna.
- 3 x PG11 cable glands.
- 2 x PG9 blind plugs.

Physical Characteristics

- Encapsulation:
Durable Polycarbonate plastic.
- Approx. 680 gram without accessories.
- W 130 x H 180 x D 60 mm.
(without SMA and PG connectors).

Environmental Specification

- Operating temperature: -30 to 60°C.
- Battery charge temperature:
-10 to 45 °C
- Recommended storage temperature:
0 to 45°C.
- Humidity: 5..90% (non condensing).
- Ingress Protection: IP65.

Approvals

- CE. EU EMC directive 2004/108/ EU.
- Applied R&TTE directive.
- GSM engine: CE/ GCF/ FCC/ PTCRB.

Warranty

- Two-years return to factory parts and labor.
- Optional warranty up to 5 years.
(restrictions apply).

Technical data are subject to changes.

Infranet Technologies GmbH
Tempowerkring 19
21079 Hamburg
Germany

Fon: +49 40 696 47 – 260